



# LED Par 56 Short DMX

ORDERCODE 42421



**SHOWELECTRONICS FOR PROFESSIONALS**

## **Congratulations!**

You have bought a great, innovative product from Showtec.

The Showtec LED Par 56 brings excitement to any venue. Whether you want simple plug-&-play action or a sophisticated DMX show, this product provides the effect you need.

You can rely on Showtec, for more excellent lighting products.

We design and manufacture professional light equipment for the entertainment industry.

New products are being launched regularly. We work hard to keep you, our customer, satisfied.

For more information: [iwant@showtec.info](mailto:iwant@showtec.info)

You can get some of the best quality, best priced products on the market from Showtec.

So next time, turn to Showtec for more great lighting equipment.

Always get the best -- with Showtec !

Thank you!



**Showtec LED Par 56™ Product Guide**

**Warning**..... 2  
    Safety-instructions..... 2  
    Operating Determinations..... 3  
    Rigging..... 4

**Description**..... 5  
    Features and Overview ..... 5

**Set Up and Operation**..... 5  
    Control Modes..... 6  
    DMX Channels..... 7

**Maintenance**..... 8

**Troubleshooting**..... 8  
    No Light..... 8

**Product Specifications**..... 9

# WARNING



**FOR YOUR OWN SAFETY, PLEASE READ THIS USER MANUAL CAREFULLY  
BEFORE YOUR INITIAL START-UP!**

## SAFETY INSTRUCTIONS

Every person involved with the installation, operation and maintenance of this device has to:

- be qualified
- follow the instructions of this manual



Before your initial start-up, please make sure that there is no damage caused by transportation. Should there be any, consult your dealer and do not use the device.

To maintain perfect condition and to ensure a safe operation, it is absolutely necessary for the user to follow the safety instructions and warning notes written in this manual.

Please consider that damages caused by manual modifications to the device are not subject to warranty.

This device contains no user-serviceable parts. Refer servicing to qualified technicians only.

### IMPORTANT:

*The manufacturer will not accept liability for any resulting damages caused by the non-observance of this manual or any unauthorized modification to the device.*

- Never let the power-cord come into contact with other cables! Handle the power-cord and all connections with the mains with particular caution!
- Never remove warning or informative labels from the unit.
- Do not open the device and do not modify the device.
- Never use anything to cover the ground contact.
- Never look directly into the light source.
- Never leave any cables lying around.
- Never use the device during thunderstorms, unplug the device immediately.
- Do not insert objects into air vents.
- Do not connect this device to a dimmerpack.
- Do not switch the device on and off in short intervals, as this would reduce the lamp's life.
- Do not touch the device's housing bare-handed during its operation (housing becomes very hot).
- Do not shake the device. Avoid brute force when installing or operating the device.
- Only use device indoor, avoid contact with water or other liquids.
- Only operate the fixture after having checked that the housing is firmly closed and all screws are tightly fastened.
- Only operate the device after having familiarized with its functions.
- Avoid flames and do not put close to flammable liquids or gases.
- Always replace the lamp, when it is damaged or deformed due to the heat.
- Always keep case closed while operating.
- Always allow free air space of at least 50 cm around the unit for ventilation.

- Always disconnect power from the mains, when device is not used, before cleaning or when replacing lamp! Only handle the power-cord by the plug. Never pull out the plug by tugging the power-cord.
- Make sure that the device is not exposed to extreme heat, moisture or dust.
- Make sure that the available voltage is not higher than stated on the rear panel.
- Make sure that the power-cord is never crimped or damaged. Check the device and the power-cord from time to time.
- Make sure that no side forces can impact on the truss system.
- The cable insert or the female part in the device must never be strained. There must always be sufficient cable to the device. Otherwise, the cable may be damaged which may lead to deadly electrical shocks.
- If device is dropped or struck, disconnect mains power supply immediately. Have a qualified engineer inspect for safety before operating.
- If the device has been exposed to drastic temperature fluctuation (e.g. after transportation), do not switch it on immediately. The arising condensation water might damage your device. Leave the device switched off until it has reached room temperature.
- If your Showtec device fails to work properly, discontinue use immediately. Pack the unit securely (preferably in the original packing material), and return it to your Showtec dealer for service.
- For adult use only. Light effect must be installed out of the reach of children. Never leave the unit running unattended.
- For replacement use fuses of same type and rating only.
- This device can be installed on a flat surface or onto truss systems via the mounting bracket.
- The user is responsible for correct positioning and operating of the LED Par 56. The manufacturer will not accept liability for damages caused by the misuse or incorrect installation of this device.
- This device falls under protection class I. Therefore it is essential to connect the yellow/green conductor to earth.
- During the initial start-up some smoke or smell may arise. This is a normal process and does not necessarily mean that the device is defective.
- Repairs, servicing and electric connection must be carried out by a qualified technician.
- WARRANTY: Till one year after date of purchase.



## OPERATING DETERMINATIONS

This device is not designed for permanent operation. Consistent operation breaks will ensure that the device will serve you for a long time without defects.

The minimum distance between light-output and the illuminated surface must be more than 0,5 meters.

The maximum ambient temperature  $t_a = 45^\circ\text{C}$  must never be exceeded.

The relative humidity must not exceed 50 % with an ambient temperature of  $45^\circ\text{C}$ .

If this device is operated in any other way, than the one described in this manual, the product may suffer damages and the warranty becomes void.

Any other operation may lead to dangers like short-circuit, burns, electric shock, lamp explosion, crash etc.

*You endanger your own safety and the safety of others!*

## Rigging

Please follow the European and national guidelines concerning rigging, trussing and all other safety issues.

Do not attempt the installation yourself !

Always let the installation be carried out by an authorized dealer !

### Procedure:

- If the LED Par 56 is lowered from the ceiling or high joists, professional trussing systems have to be used.
- Use a clamp to mount the LED Par 56, with the mounting-bracket, to the trussing system.
- The LED Par 56 must never be fixed swinging freely in the room.
- The installation must always be secured with a safety attachment, e.g. an appropriate safety net or safety-cable.
- When rigging, derigging or servicing the LED Par 56, always make sure, that the area below the installation place is blocked and staying in the area is forbidden.

*Improper installation can cause serious damage to people and property !*

### Connection with the mains

Connect the device to the mains with the power-plug.

Always pay attention, that the right color cable is connected to the right place.

International	EU Cable	UK Cable	US Cable	Pin
L	BROWN	RED	YELLOW/COPPER	FASE
N	BLUE	BLACK	SILVER	NUL
	YELLOW/GREEN	GREEN	GREEN	EARTH

Make sure that the device is always connected properly to the earth!

## Description of the device

### Features

The Showtec LED Par 56 is a LED parcan with high output and great effects.

- Never change lamps again!
- 153 LEDs (51 Red, 51 Green, 51 Blue)
- 6 DMX channels

### Overview



Filterframe included

Fig. 1



Fig. 2

Backside

## Set Up and Operation

Follow the directions below, as they pertain to your preferred operation mode.

Before plugging the unit in, always make sure that the power supply matches the product specification voltage. Do not attempt to operate a 120V specification product on 230V power, or vice versa.

**Damages caused by non-observance are not subject to warranty.**

# Control Modes

## 1. AUTO Mix Color Mode

When dipswitch #9 and #10 are turned on, the LED Parcan is in AUTO Mix Color Mode.  
 - Dipswitches #1 - #7 control the changing speed.

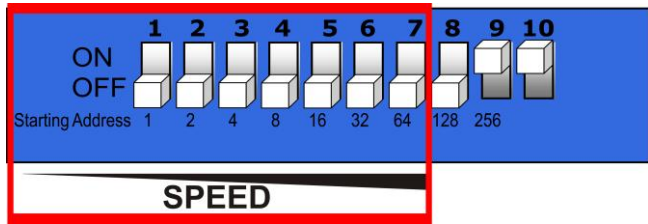

## 2. Sound Control Mode

When dipswitch #10 is turned on, the parcan will automatically change its color to the beat of the music.  
 With the Sensitivity control you can adjust its music-sensitivity.

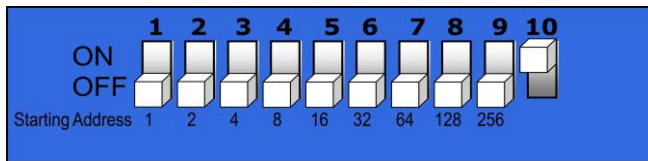

## 3. Manual Mode

When the dipswitches #8, #9 and #10 are turned on, the LED Parcan is in Manual Mode.  
 - Dip Switches #1 and #2 control the brightness of the Red LEDs  
 - Dip Switches #3 and #4 control the brightness of the Green LEDs  
 - Dip Switches #5 and #6 control the brightness of the Blue LEDs

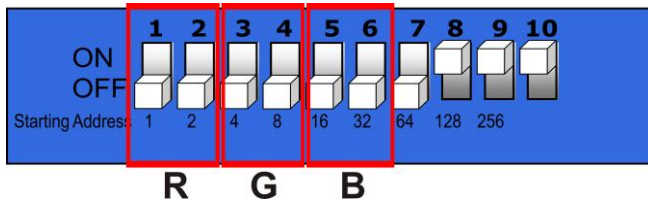

Brightness grades, Example RED :

00 (Dipswitch Setting: ) = 0%

01 (Dipswitch Setting: ) = 25%

10 (Dipswitch Setting: ) = 50%

11 (Dipswitch Setting: ) = 100%

## 4. DMX Mode

When all dipswitches are turned off, the LED Parcan is in DMX Mode.  
 - Dipswitches #1 - #9 control the DMX Addresses.

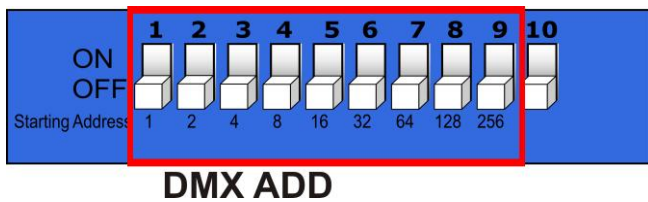



DMX products must have their own "address" to receive DMX signals. Addresses on the controller are set by flipping the appropriate DMX dipswitches.

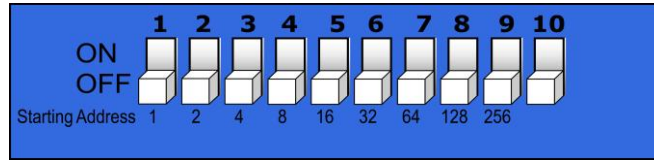

You need to know that DMX address settings are the sum of the dip switch values. A standard DMX address for a Showtec LED Par 36, which has 6 channels is as follow:

**Example**

**LED Par 36**      **Address Value**      **DMX Dip Switches "ON"**  
 Unit 5              25                              #1 , #4, #5

Switch	Value
#1	1
#4	8
#5	16 +
Total sum	25

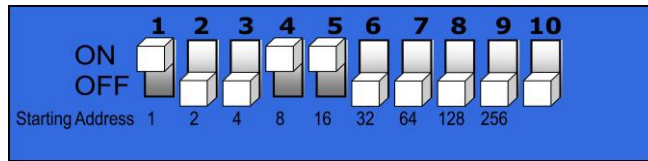

Explanation: Since each unit has 6 channels, each address advances 6 values (See Address Value above).

Once address values are determined, add DMX dipswitch values to obtain the appropriate address (DMX Dip Switches "ON") for each unit. Flip appropriate DMX dipswitches on each unit.

**DMX Channels**

**Channel 1 – „R“**

**Channel 2 – „G“**

**Channel 3 – „B“**

**Channel 4 – Full Color**

**Channel 5 – Strobe and Speed**

**Channel 6 – Modi**

Mode 1	Mode 2	Mode 3	Mode 4
0 - 63 RGB control	64 – 127 7 color fade	128 – 191 7 color change	192 – 255 music-controlled

## Maintenance

The operator has to make sure that safety-relating and machine-technical installations are to be inspected by an expert after every four years in the course of an acceptance test.

The operator has to make sure that safety-relating and machine-technical installations are to be inspected by a skilled person once a year.

The following points have to be considered during the inspection:

1. All screws used for installing the device or parts of the device have to be tightly connected and must not be corroded.
2. There may not be any deformations on housings, fixations and installation spots.
3. Mechanically moving parts like axles, eyes and others may not show any traces of wearing.
4. The electric power supply cables must not show any damages or material fatigue.

The Showtec LED Par 56 requires almost no maintenance. However, you should keep the unit clean. Otherwise, the fixture's light-output will be significantly reduced. Disconnect the mains power supply, and then wipe the cover with a damp cloth. Do not immerse in liquid. Wipe lens clean with glass cleaner and a soft cloth. Do not use alcohol or solvents.

Keep connections clean. Disconnect electric power, and then wipe the DMX and audio connections with a damp cloth. Make sure connections are thoroughly dry before linking equipment or supplying electric power.

## Troubleshooting

This troubleshooting guide is meant to help solve simple problems.

If a problem occurs, carry out the steps below in sequence until a solution is found. Once the unit operates properly, do not carry out following steps.

1. If the device does not operate properly, unplug the device.
2. Check the power from the wall, all cables etc.
3. If all of the above appears to be O.K., plug the unit in again.
4. If you are unable to determine the cause of the problem, do not open the LED Par 56, as this may damage the unit and the warranty will become void.
5. Return the device to your Showtec dealer.

## No Light

This troubleshooting guide is meant to help solve simple problems. If a problem occurs, carry out the steps below in sequence until a solution is found. Once the unit operates properly, do not carry out following steps.

If the light effect does not operate properly, refer servicing to a technician.

Response: Suspect two potential problem areas: the power supply or the LEDs.

1. Power supply. Check that the unit is plugged into an appropriate power supply.
2. The LEDs. Return the LED Par 56 to your Showtec dealer.

## Product Specification

Model: Showtec LED Par 56

Voltage: 240V-50Hz (CE)

Fuse: F2A 250V

Power: 15W

Weight: 1,56 kg

### Minimum distance:

Minimum distance from flammable surfaces: 0.5m

Minimum distance to lighted object: 1.3m

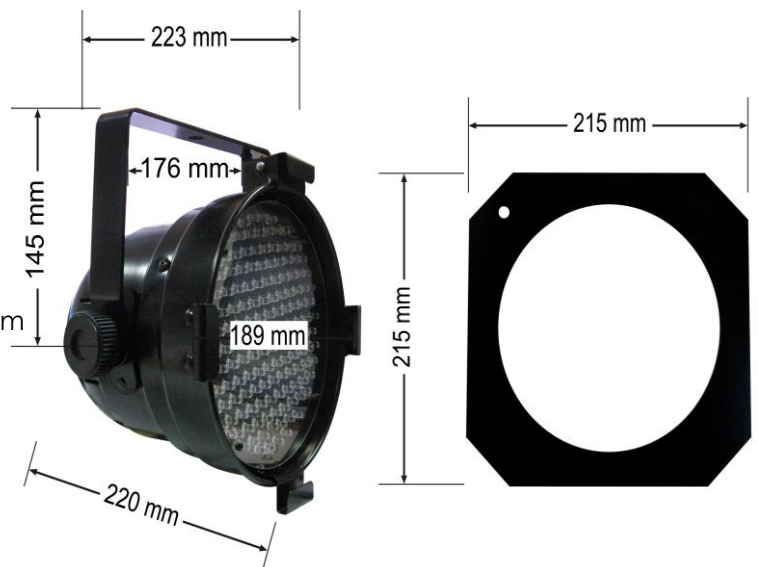

Design and product specifications are subject to change without prior notice.



Website: [www.Highlite.nl](http://www.Highlite.nl)

Email: [service@highlite.nl](mailto:service@highlite.nl)





© 2007 Showtec.